

# shower panel

MODEL : GRUMMY

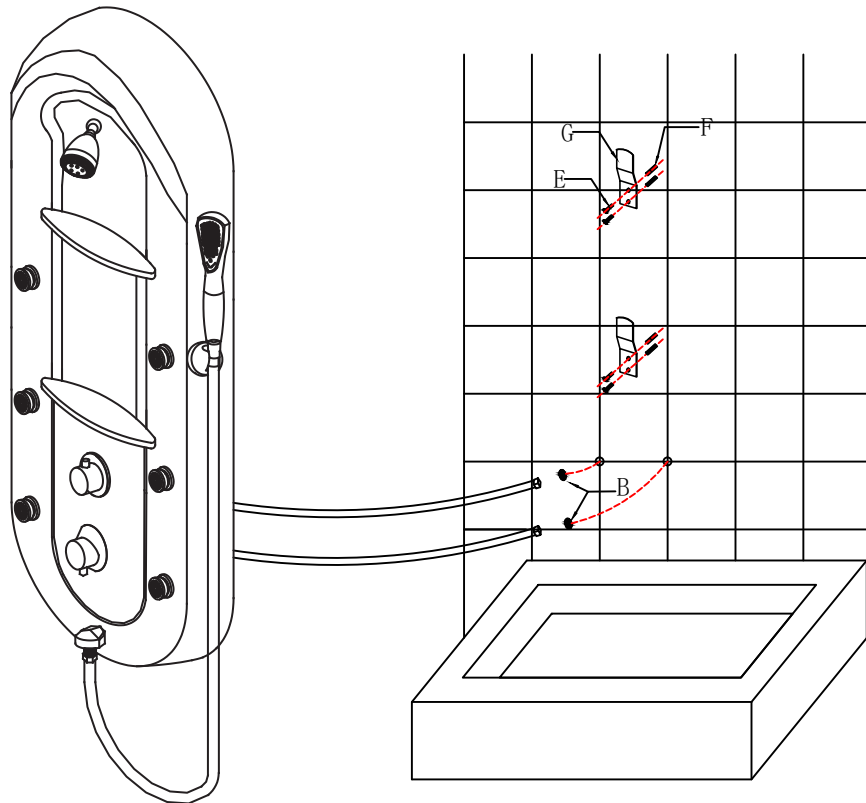

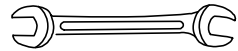

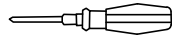
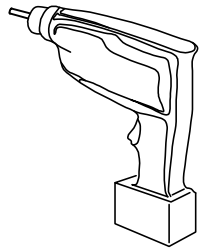
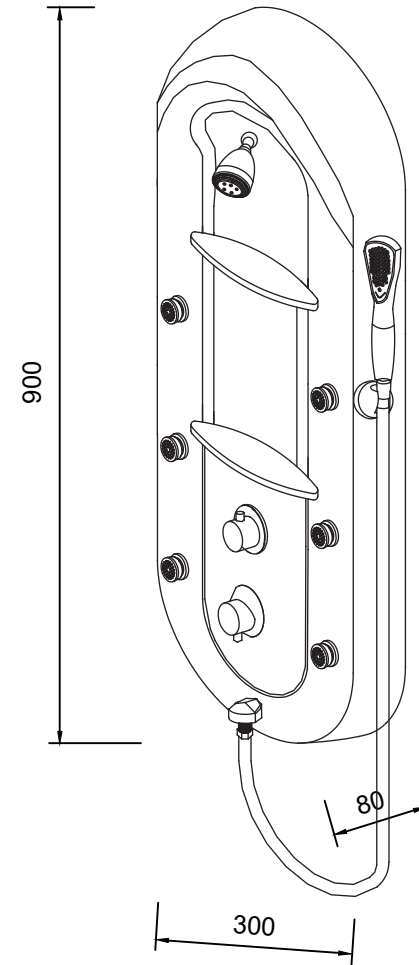

PaGE 3

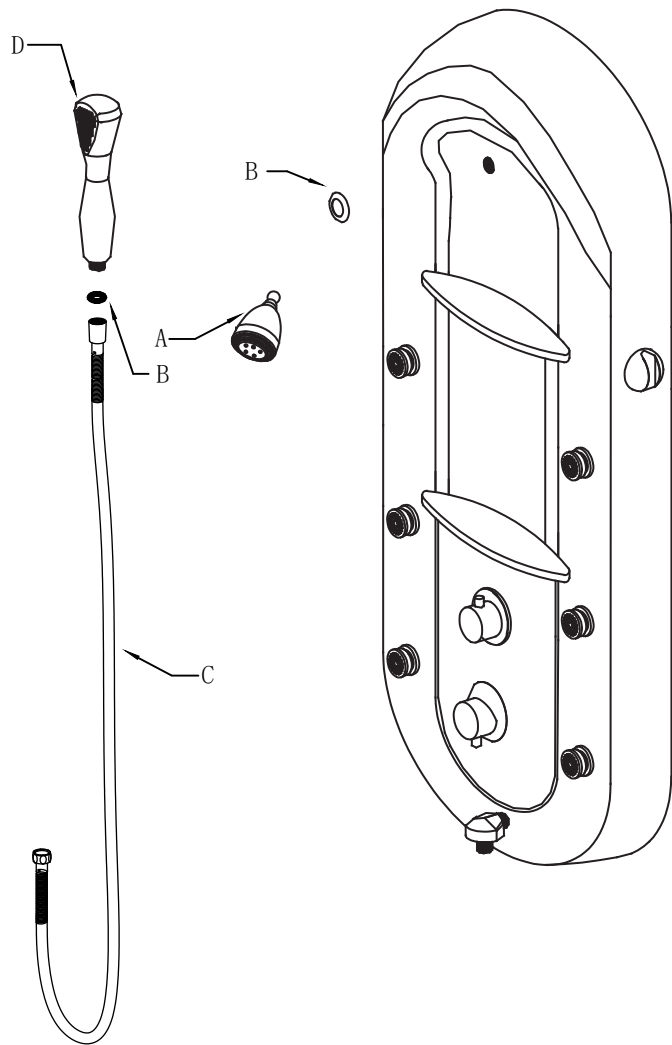

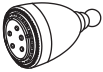
PaGE 1

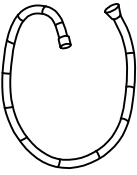
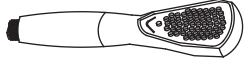
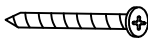

TEILE NR	ABBILDUNG	STK
A		1
B		3
C		1
D		1
E		4
F		4
G		2